

# Passive Infrared Detector · PID-1

The PID-1 is a low cost motion sensor with Multi-Focus technology and selectable sensitivity to create 4 precise detection pattern selections.

Features:

- ) Dual purpose optics: wide-angle 35ft. x 35ft. or long-range 55ft. x 5.5ft.
- ) Selectable Multilevel & Pet Alley Detection patterns
- ) Patented Multi-Focus Lens
- ) RFI Protection : 20V/m
- ) Selectable Pulse Count : 2 or 4
- ) LED On/Off Switch
- ) Tamper Switch



ELECTRICAL SPECIFICATIONS	
Relay Contact:	1 Form C, 0.2A@28V MAX
Supply Voltage:	9.5-14VDC
Standby Current :	8mA maximum @ 12V
Alarm Current:	11mA maximum @ 12V
Operating Hum.:	95% RH MAX
Temperature Range:	-20°C to 50°C (-4F to 122F)

MECHANICAL SPECIFICATIONS	
Dimensions:	2.6in x 4.25in x 1.73in (W x H x D) 66mm x 108mm x 44mm
Weight:	3.2oz (90 g)

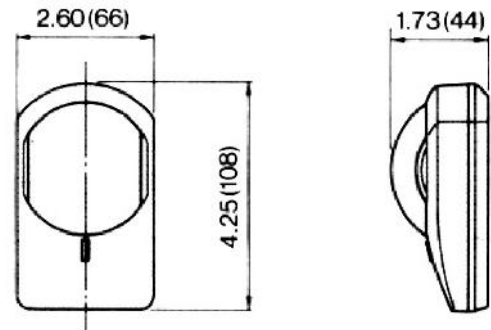

Inches (mm)

# Passive Infrared Detector Installation • PID-1

## I. DESCRIPTION AND OPERATION

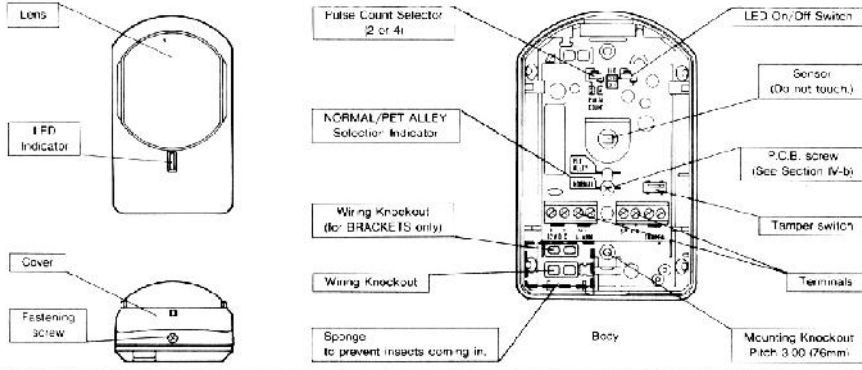

## II. INSTALLATION METHOD

- Loosen fastening screw and remove cover.
- Mount the unit and wire according to Section V.
- Replace the cover and supply power to unit.  
[warm-up period is complete (Apx. 30 sec.)]
- Conduct Walk Test.
- Pulse count according to your coverage needs and environmental conditions. Fasten cover with fastening screw.

## III. DETECTION AREA

### WIDE ANGLE TOP VIEW

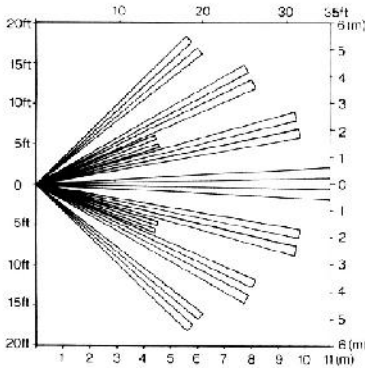

### SIDE VIEW

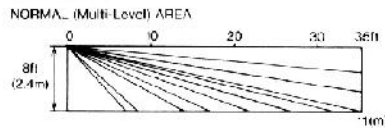

### PET ALLEY AREA

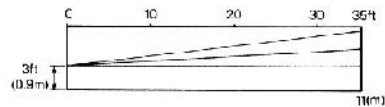

### MAX. Detection Distance/Height

Installation Height	2ft (0.6m)	3ft (0.9m)	4ft (1.2m)	5ft (1.5m)	6ft (1.8m)	7ft (2.1m)	8ft (2.4m)
NORMAL	15ft (4.5m)	23ft (7.0m)	30ft (9.0m)	35ft (10.6m)	35ft (10.6m)	35ft (10.6m)	35ft (10.6m)
PET ALLEY	35ft (10.6m)	36ft (11.0m)	36ft (10.9m)	—	—	—	—

### LONG RANGE TOP VIEW

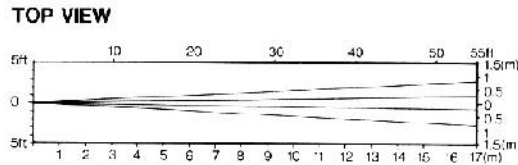

**IMPORTANT**  
WHEN SELECTING THE LONG RANGE DETECTION PATTERN, ALWAYS SET PULSE COUNT SELECTOR ON "2".

### SIDE VIEW

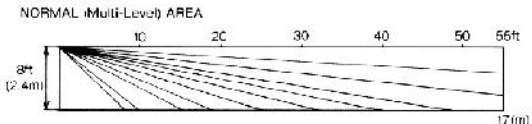

### PET ALLEY AREA

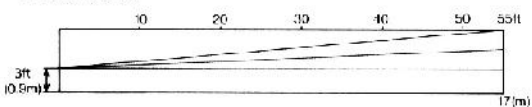

### MAX. Detection Distance/Height

Installation Height	2ft (0.6m)	3ft (0.9m)	4ft (1.2m)	5ft (1.5m)	6ft (1.8m)	7ft (2.1m)	8ft (2.4m)
NORMAL	17ft (5.0m)	33ft (9.9m)	42ft (12.5m)	55ft (17.0m)	55ft (17.0m)	55ft (17.0m)	55ft (17.0m)
PET ALLEY	55ft (17.0m)	55ft (17.0m)	42ft (12.5m)	—	—	—	—

## IV. AREA PATTERN SELECTION

### a) SELECTING WIDE ANGLE OR LONG RANGE PATTERNS

NOTE: The detection pattern is preset to the "W" (Wide Angle) position.

- Inverting the lens will select either the Wide Angle or Long Range detection patterns.
- Please note markings "W" (Wide Angle) and "L" (Long Range), on each side of lens.

- For Wide Angle detection the "W" points downward.
- For Long Range detection the "L" points downward.

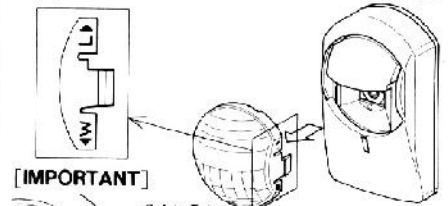

**IMPORTANT**

When the "L" (Long Range) pattern is used the "Safety Tab" MUST be removed (See illus.), and the Pulse Count Selector set at "2".

Verify Pattern Selection / Lens Position, as follows.

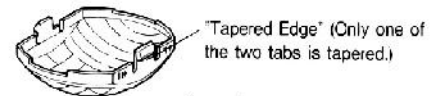

— Example —

For Wide Angle patterns, the tapered edge on the Lens (See illus.) points to the "W" on the cover.

For Long Range, the tapered edge points at the "L".

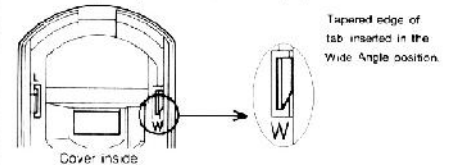

### b) SELECTING NORMAL (Multi-Level) or PET ALLEY DETECTION PATTERNS.

(Detector is pre-set at the "NORMAL" position.)

- Loosen screw (see illus.), and slide the "P.C.B." (Printed Circuit Board) up or down to match the arrow with the desired pattern (see illus.).

— Carefully —

— Tighten screw when complete —

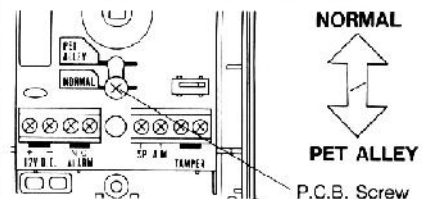

# Passive Infrared Detector Installation • PID-1

## V. WIRING

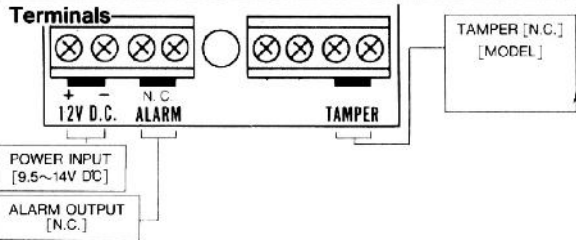

Power wires should not exceed the following lengths.

WIRE GAUGE	12V DC	14V DC
	AWG22 (0.33mm <sup>2</sup> )	1070'(320m)
AWG20 (0.52mm <sup>2</sup> )	1700'(510m)	3400'(1020m)
AWG18 (0.83mm <sup>2</sup> )	2700'(820m)	5300'(1600m)

When using two or more units on one wire, the maximum length is obtained by dividing the maximum wire length listed above by the number of units used.

- UL requires the units to be connected to a UL listed power supply capable of providing a nominal input of 12VDC(9.5~14V DC) 18mA(max.)

## VI. INSTALLATION HINTS

- Avoid direct sunlight.
- Avoid looking directly at air conditioning or heating vents.
- Avoid vapor or high humidity that can cause condensation.
- Do not install outdoors.

## VII. TROUBLE SHOOTING AND MAINTENANCE

PROBLEM	PROBABLE CAUSE	REMEDY
LED does not light.	Incorrect power supply voltage. (disconnection, low voltage)	Correct the voltage supply to 9.5~14V DC.
	Incorrect detection area.	See Section III
	Incorrect polarity to detector.	Switch positive and negative at terminal.
LED lights even though no person within area.	LED switch is OFF	Turn on the Switch.
	Moving object within area. (curtain, wall hanging, etc.)	Remove object from detection area.
	Rapid temperature changes within area. (heater, air-conditioner, etc.)	Remove the sources from detection area.
LED continues to light	Poor connection of alarm memory.	Reconnect wire.
	Wrong control voltage from panel.	Must be 0~1 V DC. (grounded) See Section VI
LED lights but signal is not sent.	Relay contact is stuck or damaged due to overloading.	Check load of output. The unit needs repair or replacement.
	Faulty Wiring	Wire correctly.

※ Conduct a walk test at least once per year.